

A 'discriminating' metal detector

This metal detector operates just like the bought ones but costs only one-third to one-half as much to build it yourself. It features three discriminate ranges plus VLF operation and includes an auto-tune button.

design: **Lee Allen, Altek Instruments, UK**
 article: **Phil Wait**

"GOLD FEVER," shrieked the news headlines following the finding of the 27 kg Hand of Faith nugget at Wedderburn in Victoria recently. It was unearthed by a couple of amateur fossickers using a metal detector, just about the most sophisticated tool ever brought to bear in the hunt for gold.

Designs for metal detectors genuinely able to discriminate between 'trash' and 'treasure' have generally been well kept trade secrets. Even the general principles of operation have been veiled in mystery. However, we are indebted to Lee Allen of Altek Instruments of the UK for providing us with the circuit design of this metal detector project via our British edition. The design incorporates all the features and refinements of modern commercially-made instruments and features performance equivalent to units costing two to three times as much.

Principles of operation

This detector employs the basically well-known *induction balance* technique to detect the presence of a metallic 'target' in the ground, but

includes a number of refinements which respond to certain characteristics of the target. The 'search head' contains two coils: an outer coil which is connected to a low frequency oscillator operating somewhere in the range 15 - 20 kHz, and an inner coil which is placed so that it is only very loosely coupled to the

outer coil. The latter is connected to the 'receiver' input of the instrument. Being only very loosely coupled, the signal induced in the receiver (inner) coil from the transmit (outer) coil is very small when a target is not in the vicinity of the search head.

When the search head approaches a metallic target, the target will have a number of influences on the two coils. Firstly, the magnetic field pattern of the transmit coil will be disturbed, and thus

the coupling between the transmit and receive coils will be increased. This generally produces an increase in the signal from the receive coil. In simple induction balance detectors, such as the ETI-549 (May 1977), this signal increase is detected and used to gate an audio oscillator on so that a tone is



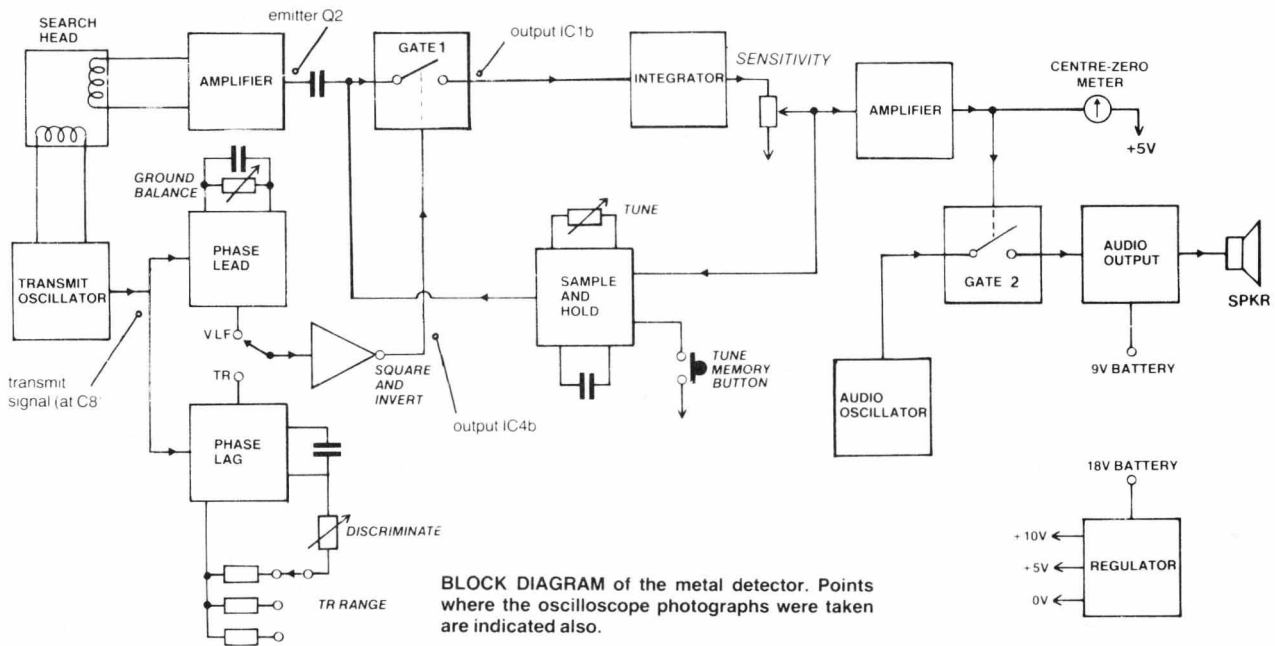

passed to a speaker or headphones.

That's all quite straightforward, but there are other influences to be taken into account. The ground in which a target is buried can have quite a profound effect on the coils in the search head. Firstly, if the ground is basically non-conducting, then it will have a permeability considerably different to that of air. This will affect the coupling between the two coils in the search head, increasing the coupling if the transmit and receive coils are initially set up away from the influence of the ground. You can compensate for this effect by physically varying the position of one coil in relation to the other when the search head is near the ground. However, different soils will have different compositions and thus have different values of permeability — even within quite a small area. The best way to compensate is by electronic means and well go into that shortly.

If the soil contains an appreciable amount of iron minerals (magnetite, hematite etc... often referred to as "iron stone soils"), or mineral salts of one type or another, then it will be partly conducting.

Such soils will have a permeability often greater than basically nonconducting soils, affecting the coupling between the coils in the search head in a similar way to that just explained. Again, as the composition of the soils varies, so will the coupling. Another

effect is that of 'eddy currents' induced in the conductive soil. The ac magnetic field of the transmit coil will induce a current in the ground beneath the search head and the eddy current has an effect opposing the permeability effect of the soil — and the whole effect varies in a complex and unpredictable way as you sweep the search head over the ground.

The only way to compensate for these varying, and generally unpredictable effects, is to devise circuitry that 'recognises' the effect.

Permeability effects will vary the phase as well as the amplitude of the signal coupled into the receive coil from the transmit coil while eddy current effects vary the amplitude. Knowing that, one can devise appropriate circuitry to take the effects into account.

However, we need to know how a metallic target affects the phase and amplitude of the receive signal. If the target is ferrous, it will have a much greater effect on the magnetic field of the transmit coil than will the surrounding soil as its permeability is greater and it will 'bend' or concentrate the field lines to a much greater degree. If the target is non-ferrous it will have a permeability effect opposite to that of ferrous targets, deflecting the field lines, but eddy currents also have some influence.

The eddy current effect in a target depends on the electrical and physical characteristics of the target. Metals

which are good conductors will have greater induced eddy currents than metals which have a higher resistivity. It is a fortunate accident of nature that gold and silver are good conductors (low resistivity) while iron (especially if its oxidised or rusty) is not so good a conductor.

If the target is ring-shaped then the eddy current effect is enhanced, whereas if it's a broken ring or just a peculiarly-shaped mass, the eddy current effect is less pronounced. The 'attitude' or orientation of the target will also affect the eddy current effects. If the main plane of the target object is aligned such that the field lines from the transmit coil cut it at right angles, then the eddy currents induced will be at a maximum. If the main plane of the target is aligned parallel to the transmit field then the eddy currents induced will be at a minimum. Obviously, the attitude of the target with respect to the transmit coils field will vary as the head passes over it and the eddy current effect will vary accordingly — it may not be maximum beneath the centre of the search head.

The permeability and eddy current effects combine in the receive coil and the signal varies in phase and amplitude in characteristic ways.

The instrument

The best way to understand how this instrument operates is to look at it in

block diagram form. The accompanying diagram shows the basic circuit blocks employed. The transmit oscillator drives the transmit coil in the search head and supplies a signal to two phase control circuit blocks. The signal from the receive head is first amplified and then ac-coupled to the input of a gate (gate 1). This gate is controlled by the output from one or other of the phase control circuits via a block which 'squares up' and inverts the signal. The output gate consists of an ac signal superimposed on a dc level. This passes to an integrator which obtains the *average* dc level of the composite signal. This is then passed to both a dc amplifier which drives a centre-zero meter, and to a 'sample and hold' circuit. The output of this block provides a dc level to the input of gate 1 which is a measure of the average dc level of the composite signal. The initial dc level applied to the input of gate 1 is actually established by the *tune* control. Thus, a dc negative feedback path is provided.

In addition to meter indication, an audio indication is provided. The output of the dc amplifier driving the meter controls a gate which switches on or off the output of an audio oscillator. This is applied to an audio amplifier and an on-board loudspeaker or headphones.

Power for the audio amplifier is provided by two 9 V batteries in parallel. The rest of the circuitry requires two supply rails at +10 V and +5 V with respect to the common rail (0 V). This is supplied by a regulator from an 18 V source consisting of two 9 V batteries connected in series.

Initially, the instrument is set up in the 'VLF' mode. The search head is held in the air and the *tune* control adjusted to bring the meter to centre zero. This is done with the *tune memory* button depressed. This activates the sample and hold circuit, storing the dc level set by the feedback loop in the capacitor of the sample and hold block. Thus, a particular dc level at the output of the integrator corresponding to meter centre zero is set up.

The search head is then lowered to the ground. Naturally, this will upset the coupling between the transmit and receive coils and the output at gate 1 will change. This will change the dc

OSCILLOSCOPE PHOTOGRAPHS

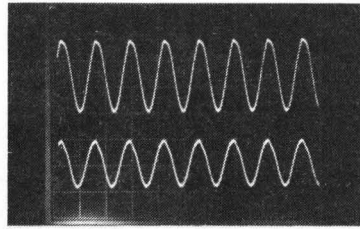

NOTE: As the effect induced by different targets is very, very small, we have had to use fairly large sample targets in order to demonstrate the operation of the instrument.

A) Top trace: transmit signal on C8 (Y-amp 5 V/div, ac-coupled)
Bottom trace: received signal on emitter of Q2 (Y-amp 5 V/div ac-coupled). Time base: 50 us/div.

VLF MODE

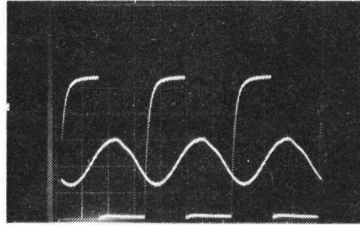

B) Received signal on emitter of Q2 (sine wave) superimposed on output of IC4b. (Both traces 2 V/div, ac-coupled; time base 20 us/div).

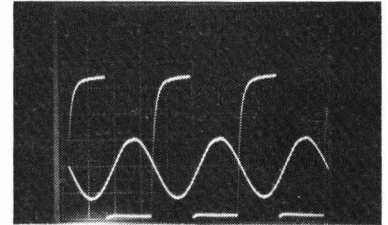

C) As per pic (B) but with aluminium target held near search head. Note the phase delay and change in amplitude of the received signal.

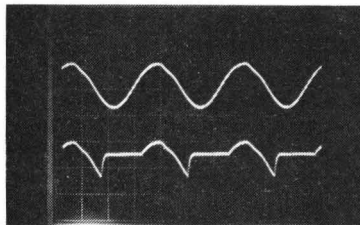

D) Top trace: received signal on emitter of Q2.
Bottom trace: output of IC1b showing composite waveform of received signal 'mixed' with a dc level. (Both traces 2 V/div, ac-coupled; time base 20 us/div).

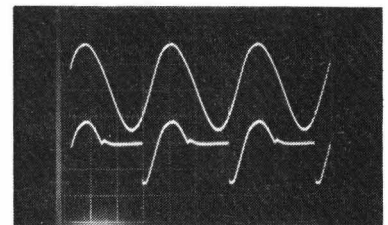

E) Same as pic (D) but with metal target near the search head. Note the increase in average dc level from the output of IC1b. The change in this signal is much larger for non-ferrous than for ferrous metals.

DISCRIMINATE MODE

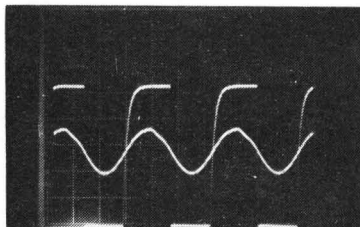

F) Received signal on emitter of Q2 (sine wave) superimposed on the output of IC4b. The phase difference between the two signals is adjustable through 180° by use of the course (TR1, TR2, TR3) and fine 'discriminate' controls. (Both traces 2 V/div, ac-coupled; time base 20 us/div).

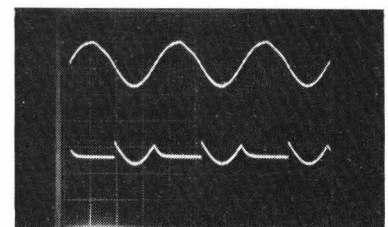

G) Top trace: received signal on emitter of Q2. Bottom trace: output of IC1b showing composite waveform of received signal 'mixed' with a dc level. Detector set to TR1 mode, discriminate control to 9. (Both traces 2 V/div, ac-coupled; time base 20 us/div).

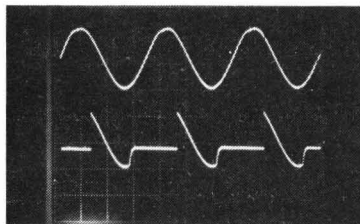

H) As per pic (G) but brass target held near search head. Note the increase in the average dc level of the signal at the output of IC1b.

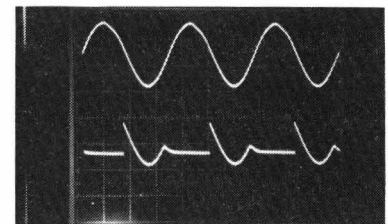

I) As per pic (G) but steel target held near search head. Note the decrease in average dc level of the signal at the output of IC1b, illustrating discrimination.

Project 1500

super metal detector

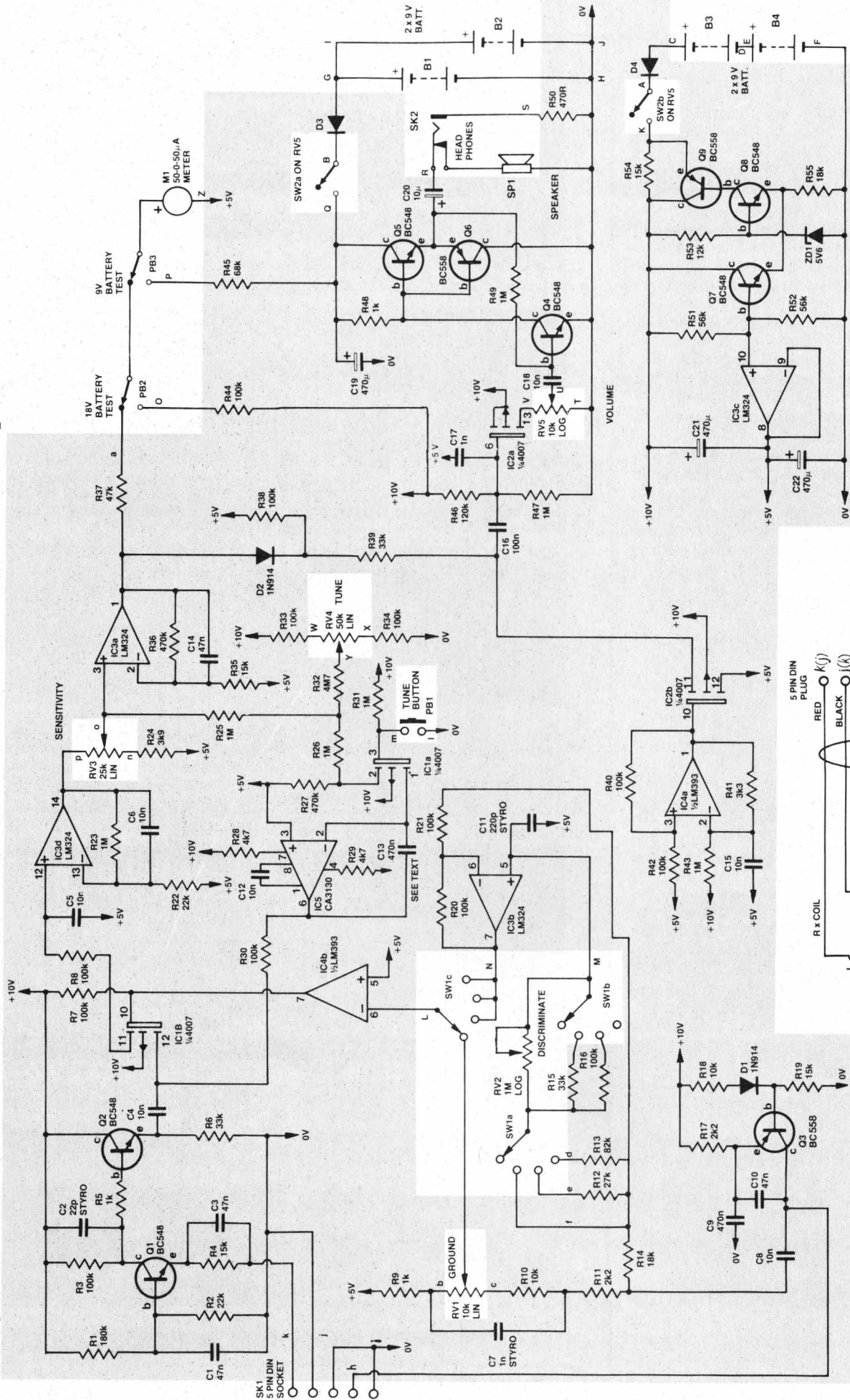

NOTES: SW1 shown in 'VLF' position. External connections via pc board pins are marked 'A, B, ...' and 'a, b, ...'. Do not confuse transistor emitter/base/collector designations with them.

OSCILLOSCOPE PICTURES taken at the following points:-
 (A) collector of Q3 and emitter of Q2. (B) emitter of Q2 and pin 7, IC4. (C) same. (D) emitter of Q2 and pin 11, IC1b. (E) same. (F) emitter of Q2 and pin 7, IC4. (G) emitter of Q2 and pin 11 IC1b. (H) same. (J) same.

- LM 324 pin 4 +10V
- pin 11 0V
- LM393 pin 14 +10V
- pin 4 0V
- 4007 pin 14 +10V
- pin 7 0V

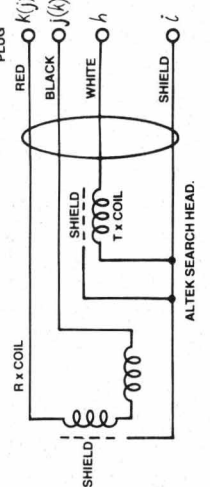

FEATURES

- VLF and T/R operation
- Three ranges of 'discriminate' (T/R) operation
- Can tune out aluminium ring-pull tabs
- Ground balance circuitry included
- Tune memory ('auto-tune') button
- High sensitivity (will detect 20c piece at depths over 250 mm)
- Pre-wound and aligned waterproof search head
- Straightforward construction, no alignment necessary
- Low battery drain
- Uses common No. 216 transistor radio batteries
- Costs around \$200 in kit form

As the general principles of operation have been discussed with regard to the block diagram in the text, this description is confined to the Circuit alone.

Commencing with the transmitter, Q3 is configured as a Colpitts Oscillator, the transmit coil in the search head forming the inductance which resonates with the combination C9 and C10. Bias is applied to Q3 via R18, D1 and R19. Emitter bias is provided by R17. The transmit signal to the phase-lead and phase-lag circuitry (ground and discriminate controls) is tapped off the collector of Q3 via C8 to the junction of R11 and R14. The ground control circuitry connects via R11 while the discriminate circuitry connects via R14.

The signal from the receive coil is amplified by Q1 and applied to gate 1 (see block diagram), one CMOS gate in IC1 (IC1b), via an emitter-following buffer stage, Q2. Note that Q1 is operated as a grounded-base amplifier. The phase of the received signal through Q1 and Q2 is not altered. Output from the emitter of Q2 is applied to the drain of IC1b.

The base of IC1b is driven by a square wave derived from the transmit signal, the phase of which can be varied by either the ground or discriminate controls.

In the VLF mode, the phase of the transmit signal tapped off from Q3 can be varied using RV1. This provides a phase-advanced signal that can be varied over the range from about +10° to +40°. A leading phase RC network is formed by R10 and RV1 in conjunction with C7. This signal is applied to the inverting input of an op-amp, IC4b. As this is operated at maximum gain with a high signal level at the input, it will 'square up' the signal at its output (pin 7), which drives the gate of IC1b.

In the discriminate mode, switch SW1 connects the transmit signal to circuitry which provides a lagging phase signal which can be varied over a range set by RV2 (the discriminate control) and a set of 'range' resistors: R12, R13, R15 and R16. These form a lagging phase RC network in conjunction with C11. The signal is then buffered by a non-

inverting op-amp, IC3b, and applied to the inverting input of IC4b via SW1c.

The source of IC1b is connected to an integrator stage formed around IC3d. The output of this stage is connected directly to the sensitivity control, RV3. The wiper of this potentiometer goes directly to the input of a dc amplifier, IC3a, to which we shall return shortly. The wiper of RV3 is also connected to the sample and hold circuit, via R25, which involves IC5, IC1a, the tune control RV4 and the tune memory pushbutton, PB1.

The sample and hold circuit works in the following way. The junction of resistors R25, R26 and R32 will be at a dc level determined by the dc level at the wiper of RV3 and the dc level at the wiper of RV4, the tune control potentiometer. The dc level at the wiper of RV3 will depend on the signal level and phase switched through to the integrator by IC1b. When the tune memory pushbutton PB1 is pressed, IC1a (also a CMOS switch) will apply a dc level to the input of the sample and hold circuit proportional to the dc level at the junctions of R25, R26 and R32. This will charge C13 and the output of IC5 will settle at this value. This dc level is then applied to the drain of IC1b, via R30.

Thus, the received signal and this dc level are 'mixed' at the input to gate 1 (i.e.: IC1b), the composite signal being applied to the integrator.

The meter, M1, is driven by a dc amplifier, IC3a. The input to this op-amp comes from the sensitivity control and is applied to the non-inverting input (pin 3). This stage has a gain of about 30 and a little 'smoothing' (integration) of the signal is applied around the feedback by having a capacitor (C14) connected in parallel with the feedback resistor, R36.

Apart from driving the meter, the output of IC3a is fed to the source of IC2b which gates the audio oscillator through to the audio output stage (i.e.: gate 2). The dc level from pin 1 of IC3a goes via D2 and R39 to pin 11 of IC2b. A positive bias is applied to the cathode of D2 from the +5 V rail via R38. Only when the dc

level at the output of IC3a goes higher than 0.6V above the bias applied to the cathode of D2, will IC2b be biased on.

The audio oscillator involves IC4a, configured as an astable multivibrator operating at a few hundred Hertz. The output, pin 1, is applied to the gate of IC2b. When IC2b turns on, the signal is applied to the input of the audio output stage.

One gate from IC2 is biased into its linear region and acts as a source-follower buffer at the input of the audio output stage. The volume control, RV5, is the source resistor for this stage and the output is taken from the wiper of RV5 to the base of Q4, capacitively coupled via C18.

The output stage is a simple complementary class-B stage employing a low power NPN/PNP transistor pair. The collector of Q4 drives the output stage, its collector load also providing bias to the output pair (R48). Both dc and ac feedback is applied to the base of Q4 by R49 from the output. Audio output can be from an 8 ohm speaker or headphones, via a dc isolating capacitor, C20. Headphone volume is reduced by a 470 ohm resistor, R50, in series with one lead to the headphone socket, SK2.

Power supply for the circuitry is split into two parts. The audio output stage is supplied by two 9 V batteries connected in parallel (B1 and B2). These are connected via a reverse-polarity protection diode, D3, and one pole of SW2 which is a switch on RV5.

The rest of the circuitry requires a +10V and a +5V rail, with respect to the common rail (0V). This is derived from two 9V batteries, B3 and B4, connected in series and applied to a regulator circuit via a reverse-polarity protection diode, D4, and the other pole of SW2. The regulator is basically a conventional series-pass circuit, Q9 being the regulator transistor.

The zener diode ZD1 provides a stable reference voltage for a differential pair, Q7 and Q8, the latter controlling the base current to Q9. Resistor R54 allows a small amount of current to pass to Q7/Q8 at switch-on to ensure the regulator 'starts' correctly. The

HOW IT WORKS — ETI 1500

base of Q7 is biased at half the upper supply rail voltage by R51 and R52. This voltage is buffered by an op-amp, IC3c, configured as a voltage follower, and used to drive the +5V line. Decoupling is provided by C19, C21 and C22. Note that 'battery test facilities are provided by R44/PB2 for the 18V supply and by R45/PB3 for the 9 V supply.

TUNING

During the tuning operation, when the instrument is being initially set up, the circuit works in the following way: With the tune memory pushbutton operated, IC1a is gated on and a dc negative feedback loop is established from the output of the sensitivity control, back to the input of gate 1, the drain of IC1b, via the sample and hold circuitry. A portion of the voltage from the wiper of RV3 is added to the voltage determined by the voltage divider R33, RV4 and R34. This is applied to the source of IC1a. As the tune memory button is pressed, IC1a is conducting and capacitor C13 will charge to the value of the composite voltage applied to the source of IC1a. The op-amp IC5 is a low input current device and the output, pin 6, will settle at a value equal to the composite voltage applied to its non-inverting input (pin 2). This dc level is applied to the source of IC1b and the signal output from the receive coil amplifier is mixed with it. This will bring about a reduction in the dc level of the signal applied to the integrator input, and thus a reduction in the dc level at the input of IC1a and, within a second or two, a new dc condition is established. When the dc level around the loop settles, the meter will read zero (centre) and the tune memory switch is released. The dc level at the output of IC5 (and thus at the drain of IC1b) is maintained by the charge on capacitor C13. In practice, it will drift very slowly, as C13 will be gradually discharged by the input current of IC5 and the capacitor's own leakage. For this reason, the tune memory button is located on the crook of the handle where it can be operated by your thumb every now and then to re-centre the meter.

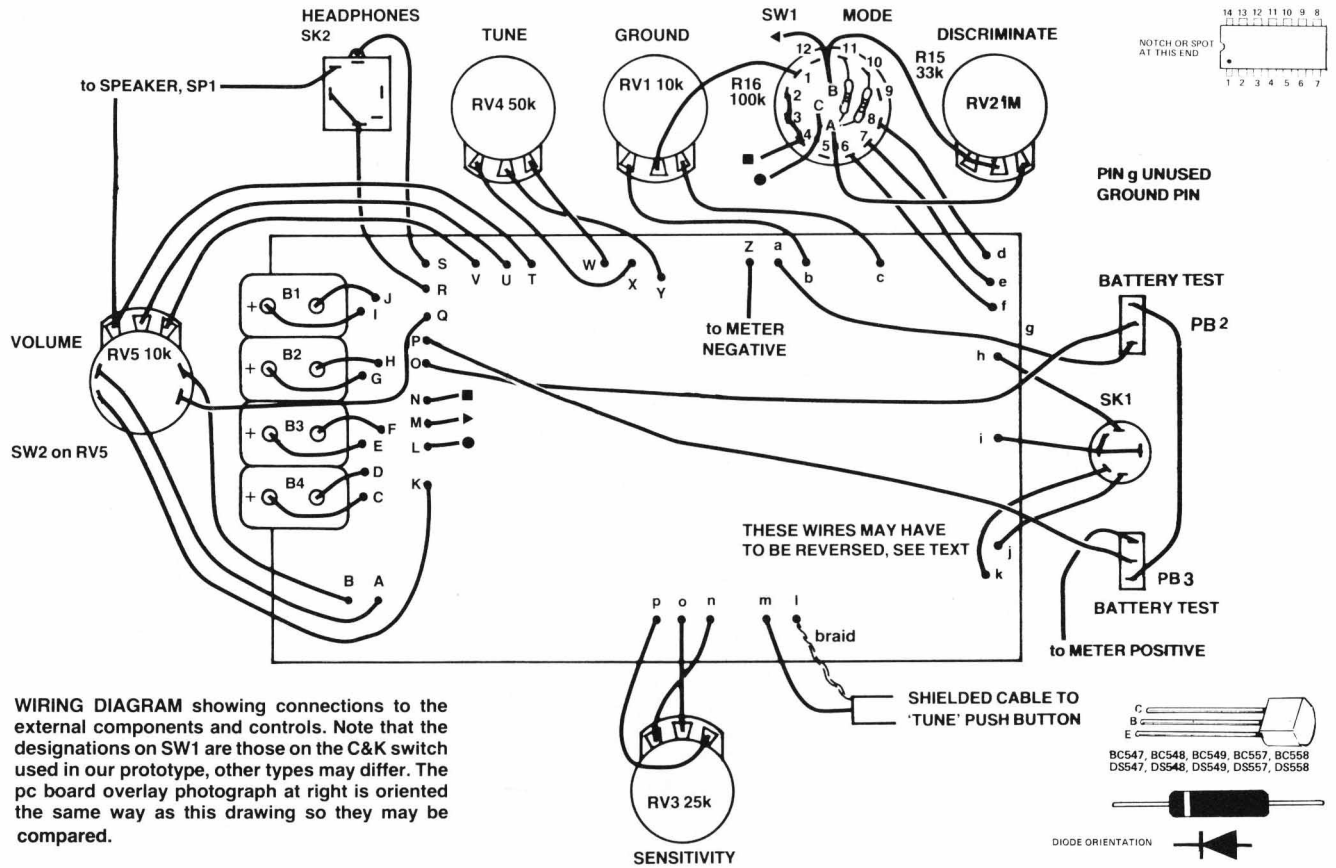

PARTS LIST — ETI 1500

Resistors all ½W, 5%.

- R1 180k
- R2, 22 22k
- R3, 7, 8, 16, 20, 21, 30, 33, 34, 38, 40, 42, 44 100k
- R4, 19, 35, 54 15k
- R5, 9, 48 1k
- R6, 15, 39 33k
- R10, 18 10k
- R11, 17 2k2
- R12 27k
- R13 82k
- R14, 55 18k
- R23, 25, 26, 31, 43, 47, 49 1M
- R24 3k9
- R27, 36 470k
- R28, 29 4k7
- R32 4M7
- R37 47k
- R41 3k3
- R45 68k
- R46 120k
- R50 470R
- R51, 52 56k
- R53 12k

Capacitors

- C1, 3, 10, 14 47n greencap
- C2 22p styroseal
- C4, 5, 6, 8, 12, 15, 18 10n greencap
- C7 1n styroseal
- C9 470n greencap
- C11 220p styroseal
- C13 470n polycarbonate or styroseal
- C16 100n greencap
- C17 1n greencap

- C19, 21, 22 470µ, 16V electrolytic
- C20 10µ, 16V electrolytic

Potentiometers

- RV1 10k linear
- RV2 1M log.
- RV3 25k linear
- RV4 50k linear
- RV5 10k log pot with DPST switch

Semiconductors

- D1, 2, 3, 4 1N914, 1N4148
- ZD1 5V6, 400mW zener diode
- Q1, 2, 4, 5, 7, 8 BC548, BC108
- Q3, 6, 9 BC558, BC178
- IC1, 2 4007
- IC3 LM324
- IC4 LM393N
- IC5 CA3130N

Miscellaneous

- SW1 three-pole, four position wafer switch; C&K type RA
 - SW2 on RV5 (DPST switch)
 - PB1, 2, 3 SPST miniature momentary push buttons, push to make
 - M1 50-0-50 µA meter, see text
 - SK1 5-pin DIN socket
 - SK2 shorting type jack socket
 - SP1 small eight ohm speaker (75 mm dia.)
 - B1 - B4 nine volt transistor radio batteries (type 216)
- Four battery clips for No. 216 batteries; ETI-1500 pc board; case (see text); handle (see text); search coil (see text); knobs; length of ribbon cable; two metre length of shielded cable; double-sided sticky tape to hold batteries in position, or a suitable clamp.

level at the output of the integrator. The *ground balance* control is then adjusted to bring the meter back to centre zero. What the ground balance circuit does is to provide a signal which leads the phase of the transmit signal and thus leads the phase of the signal induced in the receive coil without the presence of ground. The ground balance control varies the phase of this signal over a range of about four to one. Thus, when you vary the ground balance control, this varies the phase of the signal controlling gate 1, thus varying the average level of the signal passed to the integrator.

The process is then repeated until no change occurs when the search head is lowered to the ground. This establishes a 'normal' condition for the output of the integrator and the sample and hold circuit maintains the appropriate dc level at the input to gate 1 such that the meter remains at centre zero.

If the search head then approaches a metallic object, the amplitude of the signal in the receive coil will vary as the coupling between the coils and the phase of the signal will be altered by the

NOTE: C20 +VE connects to emitters of Q5 and Q6.

ETI: How To Build Gold & Treasure Detectors, 1981 — Copyright © Murray/Modern Magazines, reproduce for personal use only

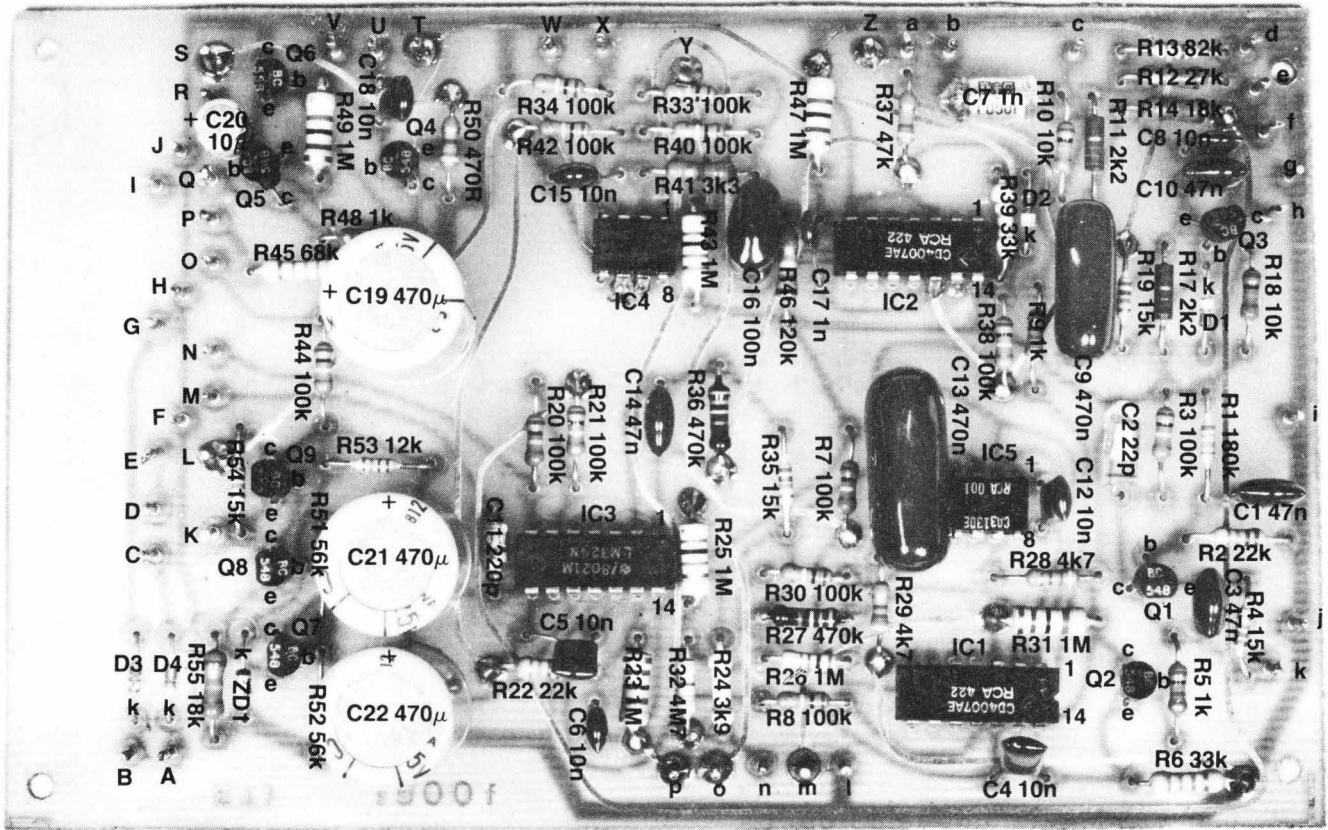

target. This will change the average level of the composite signal out of gate 1 and thus the dc level at the output of the integrator will change. This will be amplified and the meter will show an indication. Also, gate 2 will be operated and a tone will be heard in the speaker.

However, this method of operation will not indicate the difference between the characteristics of different targets.

In the discriminate or TR mode, the ground balance control is not used. The instrument is initially set up using the *tune* control to bring the meter to centre-zero. The different TR ranges permit varying degrees of control with the *discriminate* potentiometer. The phase-lag circuit block generates a signal which lags the phase of the transmit signal and the discriminate control provides a phase-variable signal to drive gate 1.

When a ferrous target is approached, the combined permeability and eddy current effects tend to reduce the amplitude of the signal picked up by the receive coil. This will cause a reduction in the dc level of the signal out of gate 1 and a reduction in the dc level out of the

integrator. Thus, the meter will move to the negative (left hand) side of the scale. This side of the scale is marked “bad”, obviously.

When a non-ferrous target is approached, the combined eddy current and permeability effect tends to increase the amplitude of the signal picked up by the receive coil. This will cause an increase in the dc level of the signal out of gate 1 and an increase in the dc level out of the integrator. The meter will thus move toward the positive (right hand — “good”) end of the scale.

The effects we are considering are actually quite small, hence the circuit has a considerable amount of do gain.

Gate 2 only operates when the output from the do amp increases (goes positive) and thus the audio output is only heard in the discriminate mode when the meter shows “good”.

It is unfortunate that ring-pull tabs from drink cans are aluminium and thus indicate along with other nonferrous metals. But, the discrimination ability of the instrument can be adjusted to exclude the small effect these targets generate — along with small trinkets,

the smaller gold nuggets, etc — but who wants the tiddlers anyway!

If the dc level applied to the input of gate 1 drifts — and it may do for a wide variety of reasons, operating the *tune memory* button will restore the balance of the circuit and re-centre the meter. Quite a cunning arrangement.

Search head

The most important properties of the search head are its size, the relationship between the transmit and receive coils, and the shielding against capacitive effects between the coils and the ground. Surprisingly, the actual inductance of the coils is not of primary importance.

The greater the coil diameter the greater the penetration depth but the less sensitive the detector will be to small objects. Penetration using simple, circular coils is about equal to the search coil diameter for small objects such as coins, while sensitivity is roughly proportional to the cube of the object diameter (expressed as a function of the search coil diameter). Sensitivity is also inversely propor-

tional to the sixth power of the distance between the coil and the object.

All this means that if the object size is halved the sensitivity is reduced to one-eighth. If the depth is doubled the sensitivity is reduced to one sixty-fourth. See why metal detectors designed to pick up small objects use small coils and really only skim the surface? If the search coil is doubled in diameter for greater penetration the sensitivity to small objects falls to one eighth, apart from the coil assembly becoming mechanically less rigid. The law of diminishing returns again or 'you don't get something for nothing'.

Our new detector improves penetration while retaining sensitivity by using a co-planar arrangement of coils in the search head which gives a slightly magnified field pattern downwards, into the ground.

We mentioned earlier that the two coils are only loosely coupled. The positioning of the receiver coil in relation to the transmitter coil is very critical and is the major factor affecting the performance of the instrument. In fact, misplacement by a millimetre or so will markedly affect the performance.

As the search head is moved around,

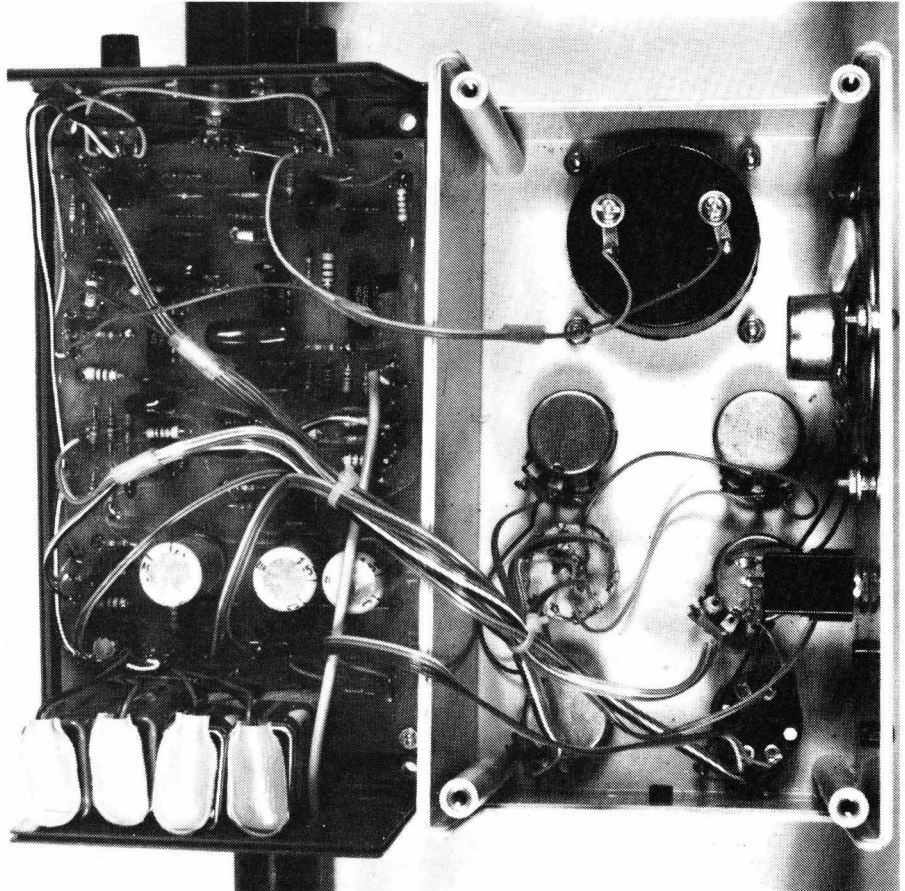

Inside the completed unit. Most of the wiring to the controls and other components external to the pc board as done using ribbon cable. The colour coding of this cable assists greatly in avoiding confusion. We suggest you place the two units as shown in this photograph to accomplish the wiring. Note how the speaker is mounted. The batteries are held in place by a strip of double-sided sticky tape.

the changing capacitance between the coils and the ground could completely mask the minute changes in the field we are looking for. To avoid this affect the coils are enclosed in a Faraday shield.

By now it should be obvious that construction of the search head is not a task to be tackled on the kitchen table on a rainy Sunday afternoon. In fact, construction and alignment of the search head would be beyond most readers' resources (anyone who has attempted our earlier induction balance metal detector knows what it's like). With this in mind we chose to use the commercially built, pre-aligned search head made by Altek Instruments. This will be available in Australia through All Electronic Components in Melbourne who have agreed to make the unit available wholesale to other suppliers, as well as retailing parts themselves, along with hardware — the plastic extendable handle and the case for housing the electronics.

Construction

The mechanical components for this project — the search head, handle and case, are available through Altek's Australian agent, All Electronic Components, as mentioned earlier. We recommend you obtain these as your finished instrument will then be a professional looking piece of equipment, with the features and operation of a 'bought one' two to three times the price. However, you can suit yourself and make your own handle if you so desire and we have designed the pc board such that it will also fit in a large jiffy box. You will have to use the search head recommended though, for the reasons we have explained previously.

All the electronics mounts on a single, double-sided pc board. The Altek case has two clamps on the rear enabling it to be clipped on to the handle. The Altek handle has two sections, the lower section sliding inside the upper section enabling the operator to

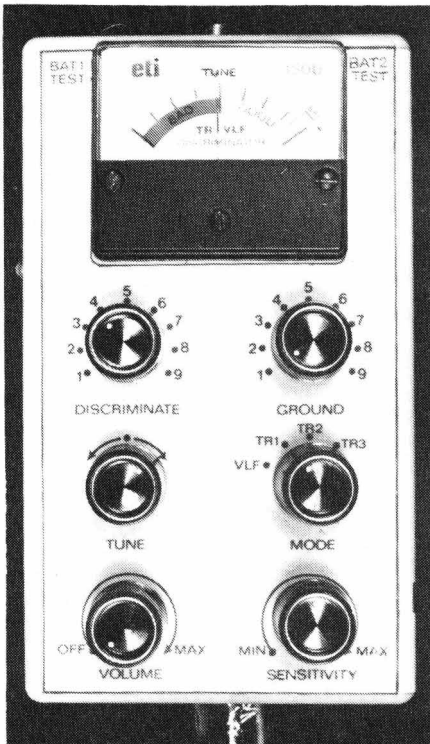

A view of the front panel of the project. The Scotchcal front panel and meter escutcheon will be available from the usual suppliers.

adjust the length of the handle to suit his height. Connection between the search head and the electronics is via a length of shielded cable (supplied with the head) and a five-pin DIN plug/socket arrangement. The *tune memory* pushbutton is mounted in the end of the 'crook' of the handle (see photographs) where it can be easily operated by the thumb. It connects to the electronics via a length of shielded cable passed through the handle.

Construction should commence with the pc board. As it is a double-sided board (i.e. copper tracks on each side), first identify the 'front' and 'rear' side. These are marked, respectively, ETI 1500f and ETI 1500r. The rear side has the more complicated pattern of tracks. The components are mounted on the *front* of the board, where there is the less complicated set of tracks. Note that some of the resistors, IC pins and pc board pins (used for connecting external wiring to the board) must be soldered to copper tracks on *each* side of the board.

Commence with the resistors. Take care with those that cross tracks that you don't create a short circuit where it's not wanted. Next mount the capacitors. Take care with the orientation of the electrolytics. Note that capacitors C2, C7 and C11 are styroseal types, used for their good temperature stability. Be careful when soldering them in place that you don't overheat the leads as this can cause melting of the capacitor's case, possibly damaging it. The sample and hold capacitor, C13, must be a low leakage type, preferably polycarbonate or mylar. We used a greencap successfully, but whatever you manage to obtain, make sure its a good quality type from a well-known supplier.

Now mount the semiconductors. Take care with the orientation of these as you can destroy devices if they are incorrectly inserted when power is applied. Finally, solder the pc pins in place and the four battery clips. The latter all go along one edge of the board.

Overall assembly of the pc board is clear from the overlay picture on page 17.

Once you have everything in place on the pc board and you're satisfied that all is OK, you can turn your attention to the

hardware. Start with the case that houses the electronics. If not pre-drilled, you'll need to mark out and drill all the holes in the case lid. The panel artwork can be used as a template. Note that we dressed up the case with a Scotchcal panel. These should be available through the usual suppliers. Centre punch holes before drilling. The cutout for the meter can be made with a hole saw or by drilling a series of 4 mm diameter holes just inside the marked edge of the hole. When you complete the circle, the centre piece can be snapped out and the edge of the hole cleaned up with a half-round file until the meter drops in neatly.

The speaker is mounted on the left hand side of the case lid (as you would normally view the unit in use). It is held in place by large washers placed under the nuts of three bolts spaced around the outer rim of the speaker. Alternatively, you can glue it in place. Be careful not to get any glue on the speaker cone or you might end up with a rather 'strangled' sound!

The pc board mounts in the bottom piece of the case, along with the DIN socket (for the search head connector) and two battery test push buttons. A small hole in the bottom passes the cable to the tune memory button. The case bottom has four integral moulded standoffs to provide support for the pc board which is held in place with screws.

Once all the mechanical work on the case is satisfactory, the Scotchcal panel

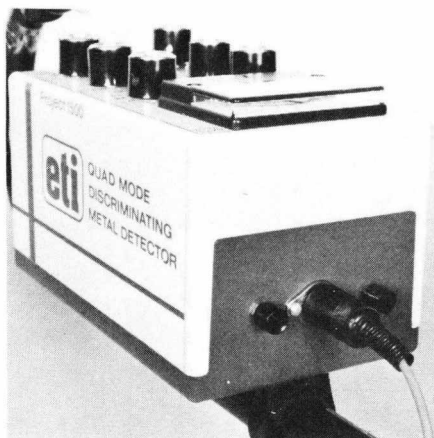

A view of the forward end of the case showing the two battery test pushbuttons and the DIN plug and socket connection to the search head. The Altek cabinet is two-tone grey plastic. The upper section is a lighter hue. Note the "GT" stripes!

may be stuck on. Take care when positioning it as it's almost impossible to move if you misalign it. Carefully smooth out all the bubbles toward the edge of the transfer.

The controls, meter etc. may be mounted next. Then you can wire all the external components to the pc board pins. We used lengths of ribbon cable where possible to simplify the wiring. The easiest way to accomplish this part of the assembly is to place the bottom of the box, with the pc board mounted in it, on your left and the lid, with the meter and controls etc. mounted, face down on your right. Follow the wiring diagram on page 16 and complete all the interconnections. You should now appreciate pc board pins!

The tune memory button mounts in a hole in the end of the 'crook' of the handle, as we explained earlier, and the shielded cable connecting to it passes through the handle, emerging through a small hole drilled in the handle near where the cable can enter the hole provided for it in the bottom of the box. This cable is best inserted before you mount the pushbutton. Remove the handgrip. Push the cable through the hole in the handle near the case, until it appears through the end of the handle. Solder the end of the lead to the pushbutton and mount the pushbutton in the hole in the end of the hand grip (easier said than done!). Put the handgrip back and you can pass the business end of the cable into the case and terminate it. If you're lucky, kit suppliers may sell the units with this part already assembled.

Holding the batteries in place is generally left to your ingenuity. We used double-sided sticky tape (ah, that's useful stuff...). The battery life is quite good as the circuit has been designed for low current drain. Reverse polarity protection is provided on the pc board to avoid problems should you inadvertently attempt to connect a battery back to front.

When all wiring is complete, push the case onto the handle and drill a small hole through one of the clamps and the stem of the handle. Insert a nail or a bolt and this will prevent the case from rotating on the handle. Mount the search head and adjust the length of the stem to suit yourself. Wrap the cable from the

search head around the stem so that it is held quite rigidly and plug it into the DIN socket on the case.

You're ready to roll!... once you've tested it.

If you wish to make the search head completely waterproof, seal the hole through which the cable passes with Silastic rubber or some similar caulking compound.

Operation

When construction is complete and you're satisfied all is well, turn the detector on and advance the *volume* control. Set all other controls to midrange and switch the *mode selector* to *VLF*. Hold the search head up in the air and well away from metal objects, press the *tune memory* button and rotate the *tune* control. The meter should swing either to side of the centre position. Set the pointer to centre scale and release the tune button. The meter should remain at this position but may drift slightly, which it will tend to do immediately after switch on. Pressing the *tune memory* button at any time should return the meter to centre position, set by the *tune* control.

The next step is to determine that the polarity of the receive coil is correct. After tuning the detector as described, bring a piece of iron near the search head. If the meter swings to the right your circuit is correct, if it swings to the left you will have to reverse the two wires on the DIN socket that connect to the receiver section on the pc board. The meter should now swing to the right.

Ground balance

With the detector tuned, lower the search head to the ground. The meter may swing off scale. If it swings to the right turn the *ground* control to the left, if it swings to the left turn the *ground* control to the right. Raise the search head from the ground, press the tune button and the meter will return to centre scale. Lower the search head again and repeat the procedure until there is little difference in the meter reading when the search head is lowered. Setting the ground control is quite critical and may take some time to achieve the first time around. The detector can now

be used in the VLF mode.

Sensitivity control

The *sensitivity* control sets the gain of the dc amplifiers in the detector and will generally give best results at midrange. If the control is set fully clockwise the tuning will tend to drift, requiring more frequent operation of the *tune memory* button.

Discriminate controls

The mode switch selects one of three discriminate ranges: TR1, TR2 or TR3, while a vernier action is provided by the *discriminate* control. The discrimination ability of this circuit is extremely effective and it is possible to discriminate between an aluminium ring pull tab and a gold ring. Remember that discrimination depends on the resistivity of the target object.

When set to TR1, *discriminate* control at mid-range, the meter should show 'bad' for ferrous objects and 'good' for non-ferrous objects along with a tone from the speaker. As the discrimination controls are advanced, some nonferrous objects such as brass will start to give a 'bad' reading, while gold and silver will give a 'good' reading. As the controls are advanced further aluminium will start to give a 'bad' reading, and so on. As you use the detector you will become familiar with its operation.

The best way of setting the discrimination controls is to carry around a few sample objects of the type you want to discriminate against just for this purpose. One thing to remember is that a corroded object will require a different setting of the controls to a non-corroded one so carry samples typical of what you are likely to dig up.

By careful setting of the controls, unwanted objects can be tuned out, giving no meter movement at all so the detector can be used to reject particular objects and at the same time discriminate between others.

Well, its now up to you. Remember, the secret of success in metal detecting is more knowing where to look than the type of detector you have. There are many books available on the subject which could help put you on the right track.

Notes for constructors

(courtesy of G.N. Vayro, Broadmeadows, Victoria).

- Take special care with the orientation of IC5 (CA3130) if an 8-pin TO-5 (circular metal case) type is supplied. Refer to the pinout diagram below.



- Take care with the wiring of the headphone socket as not all types have the same, or similar, connections. Check this by examination or with a multi-meter before wiring.

- Take care when wiring the DIN socket that connects the search head. The search head wiring is colour-coded, as shown on the circuit diagram. The red and black wires come from the receive coil. This coil has a dc resistance of around 50 ohms. The transmit coil is connected via the cable shield and the white wire. It has a dc resistance of around 12 ohms. There may be a yellow wire in the cable. Ignore it as it is not connected. The Faraday coil shields are internally connected to the cable shield.

- The wiring to the two pushbuttons PB2 and PB3 should first be sorted out with an ohmmeter before soldering it in place.

- The pushbutton in the handle needs to have good 'feel' and positive contact. One of the small C & K or Swann types should fill the bill.

- If you have or are using a metal front panel, it should be earthed to reduce spurious capacitive effects. The body of the discriminate control should connect to 0 V (Pin i) and a star washer should be inserted under its nut to provide a good contact to the panel. Otherwise, a plastic Scotchcal panel is recommended (one was used on the prototype).

- It is strongly recommended that a flux-removing solvent be used to clean the pc board following assembly. Whilst flux does not cause problems when 'new', many atmospherically bourne chemicals can and do react with

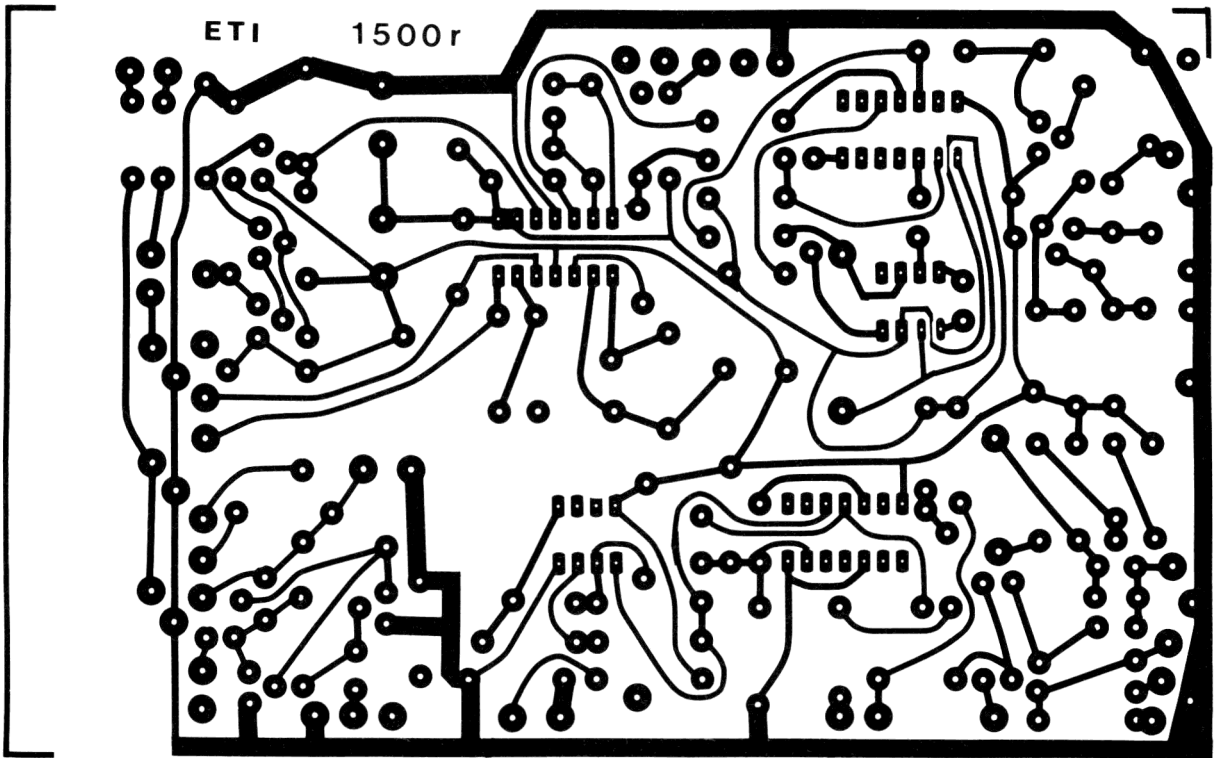
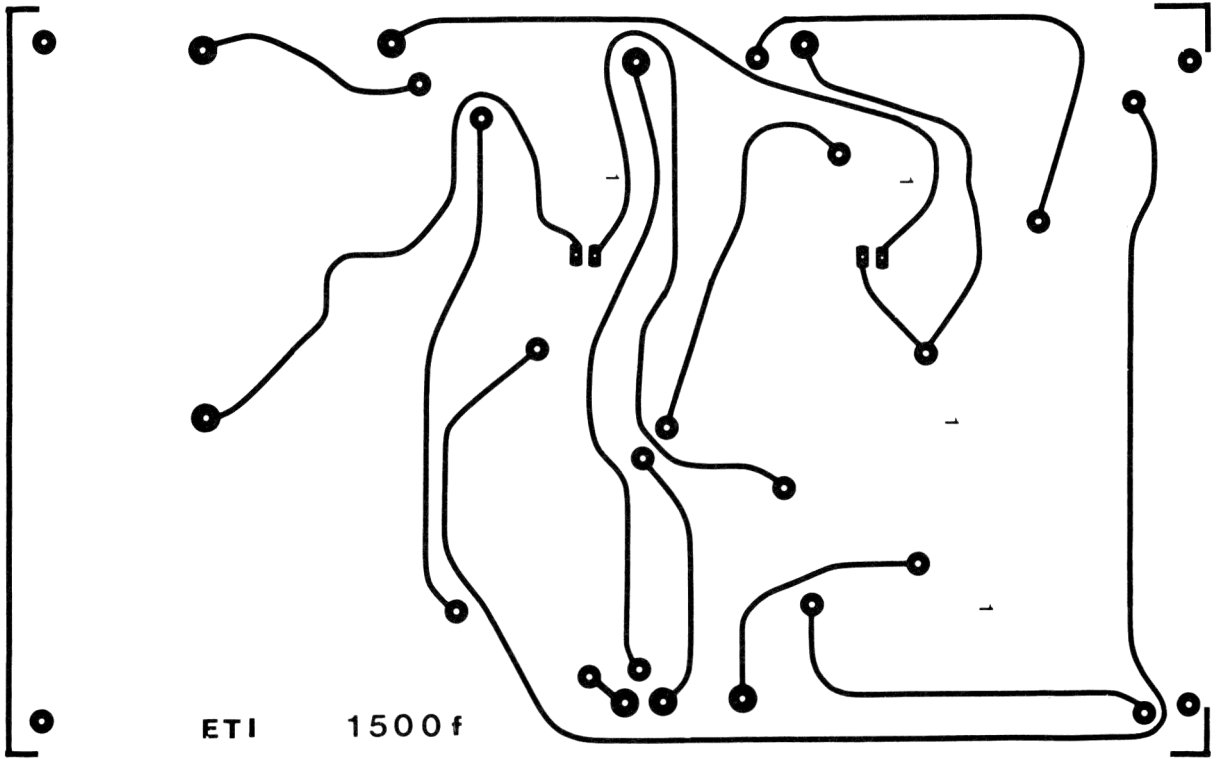

the flux in time. This causes a leakage path to be established between the tracks and is especially troublesome in high impedance circuits, such as around IC5. A de-fluxed pc board will obviate later (or early) problems with the auto-tune circuit; it also looks more professional and aids identification of defective solder joints. The effort is worth it.

- If you have trouble with hand capacitance effects, plastic knobs or

collet knobs may be used to advantage on the controls, particularly the variable discriminate control.

- The wiring to the pushbutton in the handle should be done with shielded cable, passed through a hole drilled in the rear of the case to avoid fouling the telescopic shaft in the retracted position.

- A battery clamp, fashioned from a small strip of aluminium, is recommended.

- The case should be mounted as close to the curve in the handle as possible for optimum weight distribution.

- A screw or bolt should be placed through the *rear* case mounting clip to stop the case rotating on the shaft. The rear clip is recommended to allow the shaft to be telescoped to minimum length.